



NEW

BIM READY

VICTRIX PRO V2

Wall-hung light commercial
condensing gas boiler



Ideal for central heating in
residential and commercial
buildings. Efficiency and
Hydrogen Ready technology.



VICTRIX PRO V2

Modular condensing boiler with sealed chamber and forced draught for only-heating

HIGH INSTALLATION FLEXIBILITY THANKS TO THE REDUCED DIMENSIONS

The possibility of 5-generator cascade and the high efficiency makes VICTRIX PRO V2 ideal for centralized heating of residential and commercial building. The compact and linear design, with its vertical scrolling lid for panel protection, characterizes the whole range. VICTRIX PRO V2 is available in 9 versions: 35, 55, 60, 68, 80, 100, 120, 150 and 180 kW.

HIGH PERFORMANCE ON CONSUMPTION

The wide modulation range 1:10 (up to the 120 kW version) optimizes the generator functioning even with low heating requests (for example during spring/autumn or in case of partial usage of the system).

LOW NO_x POLLUTION EMISSIONS

The complete range reaches NO_x class 6 in terms of polluting emissions, making it optimal for installation in buildings with high energy performance standards and low environmental impact.





GREATER FLEXIBILITY

VICTRIX PRO V2 boilers obtained **Hydrogen Ready certification**.

The new VICTRIX PRO V2 can work with natural gas, LPG and up to **20% blend of hydrogen**.

HYDROGEN: THE SOLUTION TO REDUCE CO₂ AND GREENHOUSE GAS EMISSIONS INTO THE ENVIRONMENT

Whereas natural gas combustion produces carbon dioxide, hydrogen does not. Since most CO₂ emissions are correlated to the heating industry, this new technology will be a key point in the fight towards a zero pollution level.

To put things into perspective the introduction of 20% hydrogen blends in our current world would mean a reduction of around 6 million tonnes of CO₂ emissions and a 7% decrease of greenhouse gases. If boilers were only supplied with hydrogen the results would be extraordinary.





INSTALLATION FLEXIBILITY

By hydraulically and electrically connecting 5 gas boilers in cascade (with a single safety kit), reaching 900 kW output power has never been this easy. The new range has now even less space requirements for cascade installation.

FLOOR-STANDING SUPPORT INSTALLATION

VICTRIX PRO V2, up to 150 V2 version, can be installed (single or multiple in cascade) on its dedicated floor-standing support kit on a linear disposition or back-to-back for limited spaces. The structure includes supports for the hydraulic manifolds and it can be fixed to the floor or to the wall with the proper pieces. The frame kit is also certified for outdoor installation.

OUTDOOR INSTALLATION IN THE CABINET KIT

The cabinet kit allows VICTRIX PRO V2, up to 150 V2 version, to be installed outdoor in a floor-standing configuration. Cascade installation is possible with multiple cabinets. For each cabinet is available an hydraulic manifold kit with INAIL safety devices included.

OPTIMAL FOR OUTDOOR INSTALLATION

Thanks to its IPX5D protection grade and to the cataphoresis treatment on the frame, VICTRIX PRO V2 gas boilers can be installed outdoor, even without protection (with the optional cover kit). Anti-freeze protection can reach -15°C with the proper optional kit.



STAINLESS STEEL CONDENSING MODULE

The complete range includes condensing module with stainless steel hydraulic circuits (for VICTRIX PRO 35, 55, 60, 68 and 80 V2 the external part is out of composite plastic).

TOTAL PRE-MIXING COMBUSTION SYSTEM

The research and development of the combustion system allow the complete range to have an high output power modulation range (from 10 to 100%). Additionally the generators can work with both natural gas and LPG.

A+ CLASS

VICTRIX PRO V2 can reach an higher energy efficiency class (A+)* if installed in combination with an IMMERGAS advanced thermoregulation panel such as the Modulating Remote Panel code 3.020358.

OPTIMAL REGULATION CONTROL

By having two NTC temperature reading probes (on the supply and return pipes) the electronics has a greater control over the functioning temperatures.

** VICTRIX PRO V2 have a seasonal efficiency of 94% (up to the 120 V2 version).*

Seasonal
efficiency 94%

A+





LOW-CONSUMPTION MODULATING PUMP AS PER STANDARD

The pump modulates its speed to keep the ΔT constant between water supply and return therefore reducing electrical absorption and noise.

INTEGRATED CONDENSATE DISCHARGE SYPHON

The integrated syphon collects the condensates and allows them to be properly discharged; the syphon is connected to a polipropylene flexible pipe which is resistant to condensate corrosion. Externally the technician has to install a dedicated proper discharge system according to the current regulations.

SAFETY VALVE

The boilers come as per standard with a safety valve 4 bar (35–80) and 5,4 bar (100–180).

NEW CONTROL ELECTRONICS

The new control electronics widens the installation possibilities.

VICTRIX PRO V2 can manage 2 water distribution zones (2 direct or 1 direct + 1 mixed) with different temperature sets and climatic curves (to be managed with on/off thermostats or OpenTherm).

In addition to the water distribution zones it is possible to manage a DHW circuit with 3-way diverting valve or with a dedicated pump. In this last case the technician can select the simultaneous functioning (useful for low-inertia systems such as fan-coils). The DHW request can be activated with an NTC sensor or on/off contact (thermostat).

For the anti-legionella function a temperature reading probe in the tank is required.

Timeslots can be set for both central heating and DHW (ECO, COMFORT, OFF).

EASY MANAGEMENT OF BOILER CASCADE

The new Cascade and Zones Regulator Kit allows you to manage and control the operation of the connected boilers by deciding which boiler to turn on, with what power and with which sequence depending on the heat demand of the type of heating system.

MANAGEMENT OF A THERMAL SOLAR SYSTEM FOR DOMESTIC HOT WATER PRODUCTION

The Cascade and Zones Regulator kit can be used to easily manage a thermal solar plant for production of DHW by installing the correct temperature probes (see page 17).

NEW REMOTE MANAGEMENT

A new optional kit is available (see page 16) capable of communicating with the Cascade and Zones Regulator kit in order to remotely monitor the system.



Main characteristics

Electrical connection to the master boiler	Temperature settings	Maximum number of boilers	Water distribution zones	Connection in series	Thermal solar system connection
2 BUS wires: max length 50 meters	Central heating: COMFORT, ECO, Anti-Freeze DHW temperature	8	3 (1 direct and 2 mixed) + 1 DHW pump	Up to n°3 Cascade and Zones Regulator kits and n°6 expansion kits. Only the master panel will be connected to the boiler	Possibility to install and manage a thermal solar system without an additional external control unit

TECHNICAL DATA

Technical characteristics	Measurement unit	VICTRIX PRO 35 V2 EU	VICTRIX PRO 55 V2 EU	VICTRIX PRO 60 V2 EU	VICTRIX PRO 68 V2 EU	VICTRIX PRO 80 V2 EU
Natural gas boiler article number		3.034431	3.033857	3.033858	3.033859	3.033860
LPG gas boiler article number		3.034431GPL	3.033857GPL	3.033858GPL	3.033859GPL	3.033860GPL
Energy class		A	A	A	A	A
Template article number		1.047417	1.047417	1.047417	1.047417	1.047417
Maximum heat input	kW	34,9	51,0	59,9	65,0	75,0
Minimum heat input	kW	3,9	5,4	7,8	7,8	7,8
Maximum effective heat output (80/60°C)	kW	33,9	49,8	58,5	63,4	73,2
Minimum effective heat output (80/60°C)	kW	3,7	5,1	7,5	7,5	7,5
Maximum effective heat output (50/30°C)	kW	36,9	54,2	63,9	69,2	79,4
Minimum effective heat output (50/30°C)	kW	4,1	5,7	8,3	8,3	8,3
Central heating seasonal efficiency η_s	%	94	94	94	94	94
Efficiency at 100% Pn (80/60°C)	%	97,0	97,6	97,7	97,5	97,6
Efficiency at 100% Pn (50/30°C)	%	105,8	106,2	106,8	106,5	105,9
Efficiency at 100% Pn (40/30°C)	%	107,7	106,8	108,3	107,8	105,8
Efficiency at partial load 30% (return flow temperature 30°C)	%	109,2	109,6	109,6	109,4	109,5
Chimney losses with burner on (100% Pn) (80/60°C)	%	2,69	2,3	2,2	2,3	2,3
Chimney losses with burner off	%	0,03	0,02	0,017	0,020	0,01
Casing losses with burner on (100% Pn) (80/60°C)	%	0,31	0,10	0,1	0,1	0,10
Casing losses with burner off	%	0,32	0,23	0,2	0,2	0,16
NO _x class		6	6	6	6	6
Weighted NO _x	mg/kWh	37	39	41	39	33
Weighted CO	mg/kWh	27	24	17	17	24
Gas flow rate to burner at max, and min. heat output with methane (G20)	m ³ /h	3,69/0,41	5,40/0,57	6,34/0,83	6,88/0,83	7,94/0,83
Maximum fan available head (max/min)	Pa	86–2	197–2	195–4	230–4	306–3
Flue exhaust mass flow rate at nominal heat output (G20)	kg/h	54/6	82/9	96/13	104/13	121/13
CO ₂ at nominal/minimum heat output (G20)	%	9,6/9,1	9,2/8,7	9,3/9,0	9,3/9,0	9,2/9,0
CO at nominal/minimum heat output (G20)	mg/kWh	257/3	235/3	171/3	192/3	246/3
Maximum/Minimum fume temperature (G20)	°C	79/60	74/60	71/65	74/65	79/65
Maximum operating temperature	°C	95	95	95	95	95
Heating system adjustable temperature	°C	15–90	15–90	15–90	15–90	15–90
Maximum operating pressure of heating circuit	bar	4,4	4,4	4,4	4,4	4,4
Electric power supply	V/Hz	230/50	230/50	230/50	230/50	230/50
Nominal power absorption	A	1,0	1,8	2,2	2,3	2,5
Installed electric power	W	130	158	295	300	320
Power absorbed by pump	W	77,8	73,0	182,0	182,0	182,0
Power absorbed by fan	W	45,0	65,0	95,0	103,0	120,0
Electrical insulation rating	IP	X5D	X5D	X5D	X5D	X5D
Full appliance weight (empty)	kg	52,4 (50,0)	59,8 (57,0)	64,2(61,0)	64,2 (61,0)	64,2 (61,0)
Appliance water content	litres	2,4	2,8	3,2	3,2	3,2

For other information regarding out of standard operating conditions please refer to the technical sheet or get in contact with IMMERGAS customer service



Technical characteristics	Measurement unit	VICTRIX PRO 100 V2 EU	VICTRIX PRO 120 V2 EU	VICTRIX PRO 150 V2 EU	VICTRIX PRO 180 V2 EU
Natural gas boiler article number		3.033861	3.033862	3.033863	3.033864
LPG gas boiler article number		3.033861GPL	3.033862GPL	3.033863GPL	3.033864GPL
Energy class		A	A	A	A
Template article number		1.047417	1.047417	1.047417	1.047417
Maximum heat input (80/60°C)	kW	93,0	114,5	141,0	170,0
Minimum heat input (80/60°C)	kW	10,1	11,7	29,0	34,7
Maximum effective heat output (80/60°C)	kW	90,9	112,3	138,3	166,9
Minimum effective heat output (80/60°C)	kW	9,8	11,3	28,3	33,8
Maximum effective heat output (50/30°C)	kW	98,8	121,7	149,9	180,2
Minimum effective heat output (50/30°C)	kW	10,7	12,4	30,8	36,8
Central heating seasonal efficiency η_s	%	94	94	93	93
Efficiency at 100% Pn (80/60°C)	%	97,7	98,1	98,1	98,2
Efficiency at 100% Pn (50/30°C)	%	106,2	106,3	106,3	106,0
Efficiency at 100% Pn (40/30°C)	%	108,2	108,4	107,2	107,5
Efficiency at partial load 30% (return flow temperature 30°C)	%	109,4	109,7	109,5	109,9
Chimney losses with burner on (100% Pn) (80/60°C)	%	2,2	1,8	1,8	1,7
Chimney losses with burner off	%	0,02	0,02	0,02	0,02
Casing losses with burner on (100% Pn) (80/60°C)	%	0,10	0,10	0,10	0,10
Casing losses with burner off	%	0,18	0,18	0,18	0,18
NO _x class		6	6	6	6
Weighted NO _x	mg/kWh	34	30	34	42
Weighted CO	mg/kWh	23	19	20	25
Gas flow rate to burner at max, and min. heat output with methane (G20)	m ³ /h	9,84/1,07	12,12/1,24	14,92/3,07	17,99/3,67
Maximum fan available head (max/min)	Pa	221-3	341-4	340-16	41-2
Flue exhaust mass flow rate at nominal heat output (G20)	kg/h	149/17	185/19	226/48	277/60
CO ₂ at nominal/minimum heat output (G20)	%	9,3/8,9	9,2/8,9	9,3/8,9	9,1/8,5
CO at nominal/minimum heat output (G20)	mg/kWh	235/7	219/4	230/7	224/11
Maximum/Minimum fume temperature (G20)	°C	74/60	71/60	73/60	72/60
Maximum operating temperature	°C	95	95	95	95
Heating system adjustable temperature	°C	15-90	15-90	15-90	15-90
Maximum operating pressure of heating circuit	bar	6	6	6	6
Electric power supply	V/Hz	230/50	230/50	230/50	230/50
Nominal power absorption	A	2,7	3,0	3,2	2,8
Installed electric power	W	330	410	580	520
Power absorbed by pump	W	183,0	183,0	258,0	298,0
Power absorbed by fan	W	155,0	220,0	247,0	200,0
Electrical insulation rating	IP	X5D	X5D	X5D	X5D
Full appliance weight (empty)	kg	104,0 (95,0)	111,0 (101,0)	124,0 (112,0)	163,0 (148,0)
Appliance water content	litres	9,0	10,0	12,0	15,0

For other information regarding out of standard operating conditions please refer to the technical sheet or get in contact with IMMERGAS customer service.



VICTRIX PRO 35/55/60/68/80 V2 EU

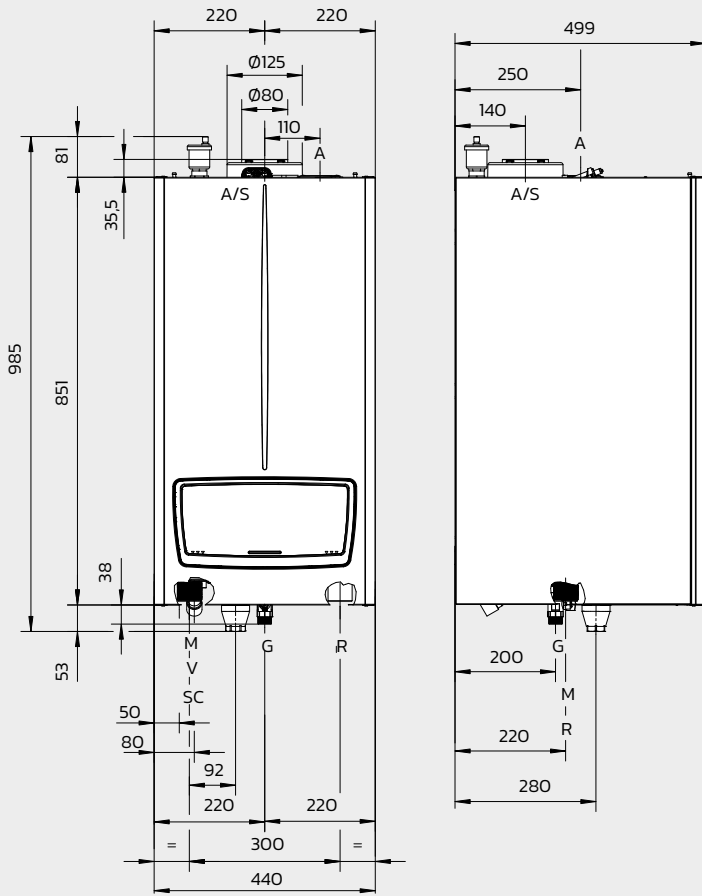

Key

V	Electrical connection
G	Gas supply
SC	Condensate drain (minimum internal diameter Ø 13 mm)
M	System flow
R	System return
A	Air intake
S	Flue expulsion
A/S	Intake/expulsion

Connections

Gas	System	
	R	M
¾"	1 ½"	1 ½"

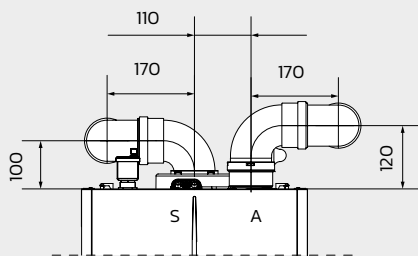

Separator kit distances
Ø 80/80

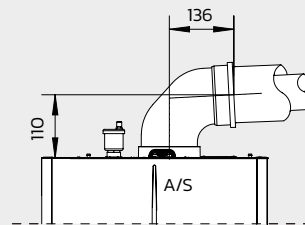

Concentric kit dimensions
Ø 80/125

VICTRIX PRO 100/120/150 V2 EU

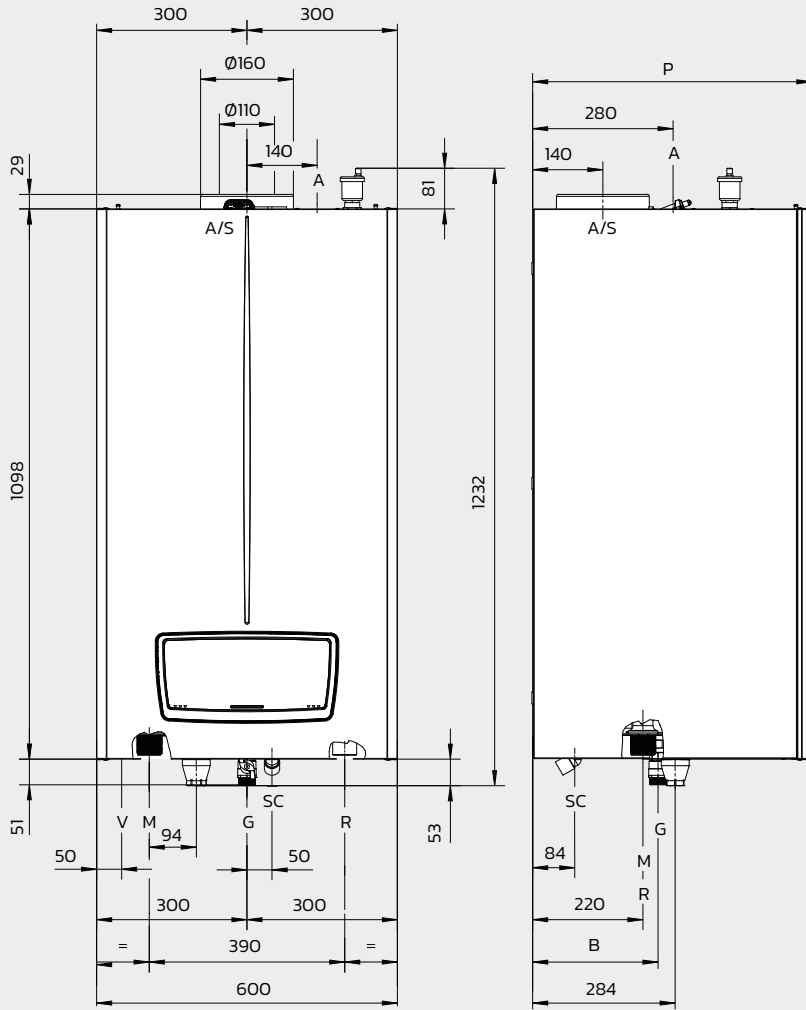

Key

V	Electrical connection
G	Gas supply
SC	Condensate drain (minimum internal diameter Ø 13 mm)
M	System flow
R	System return
A	Air intake
S	Flue expulsion
A/S	Intake/expulsion
P	VICTRIX PRO 100/120 V2 mm 557 VICTRIX PRO 150 V2 mm 627
B	VICTRIX PRO 100/120 V2 mm 250 VICTRIX PRO 150 V2 mm 370

Connections

Gas	System	
G	R	M
1"	1 1/2"	1 1/2"

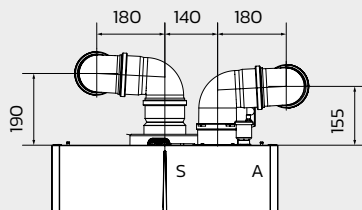

Separator kit distances
Ø 100/100

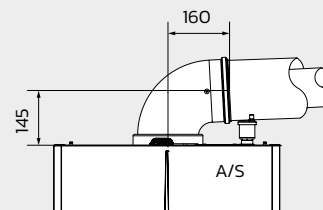

Concentric kit dimensions
Ø 110/160



VICTRIX PRO 180 V2 EU

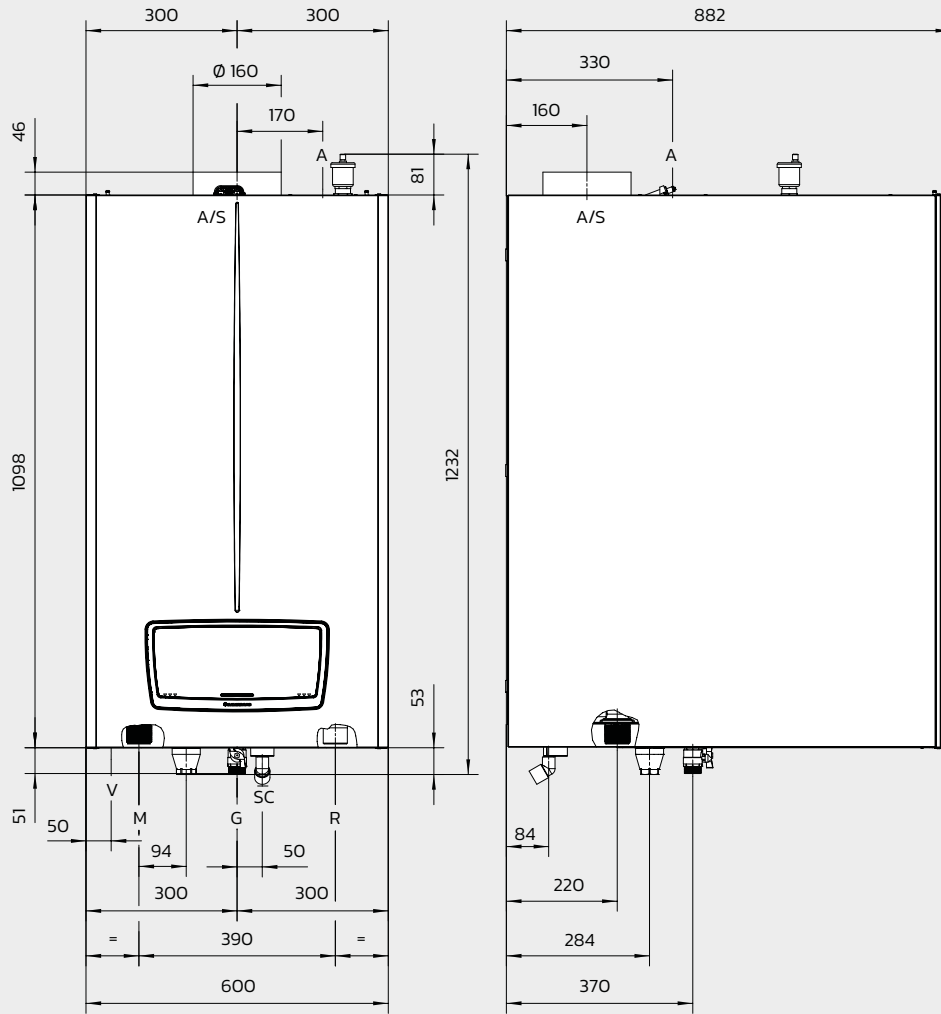

Key

- V Electrical connection
- G Gas supply
- SC Condensate drain (minimum internal diameter \varnothing 13 mm)
- M System flow
- R System return
- A Air intake
- S Flue expulsion
- A/S Intake/expulsion

Connections

Gas	System	
	R	M
G	1"	1 1/2"

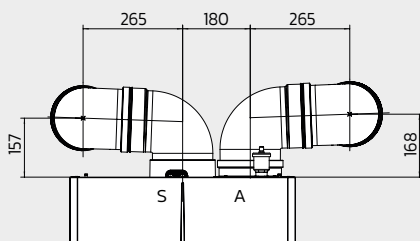

Separator kit distances
 \varnothing 160/160

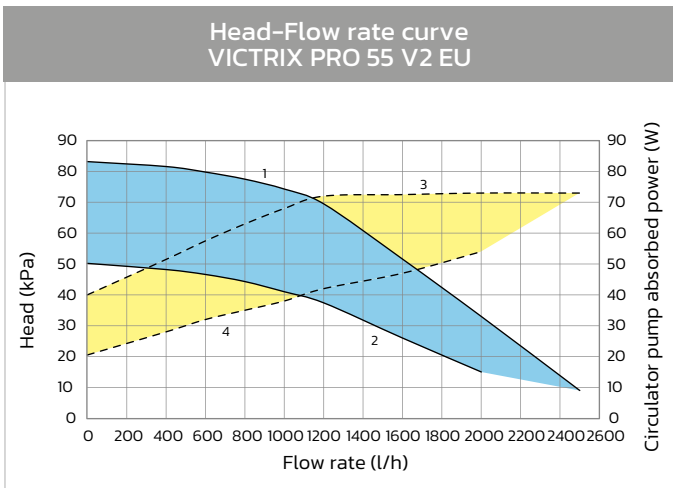
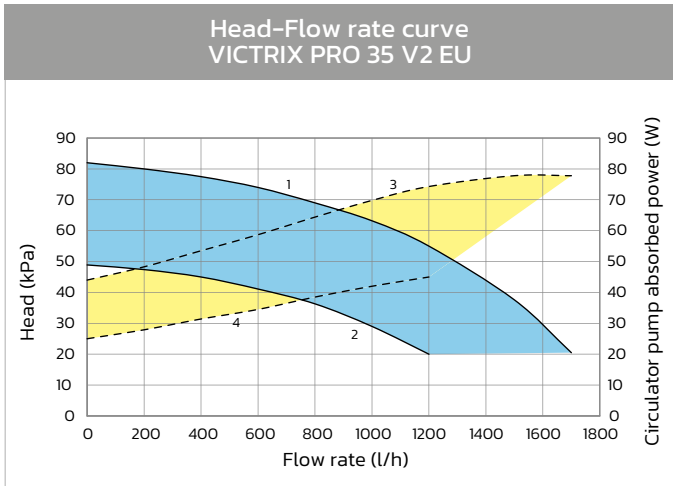

Key

- Available head
- Pump power absorption (dotted area)
- 1** at 100% speed
- 2** at 77% speed
- 3** at 100% speed
- 4** at 77% speed

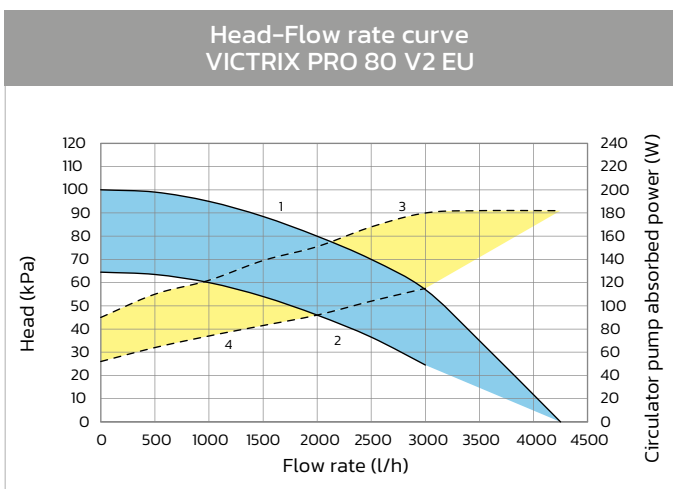

TECHNICAL DATA

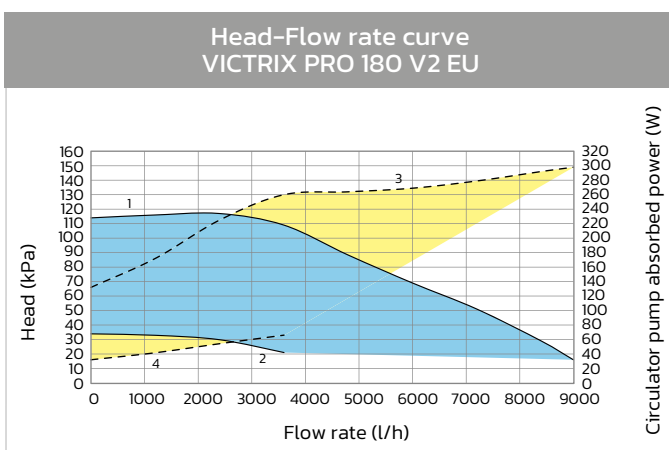
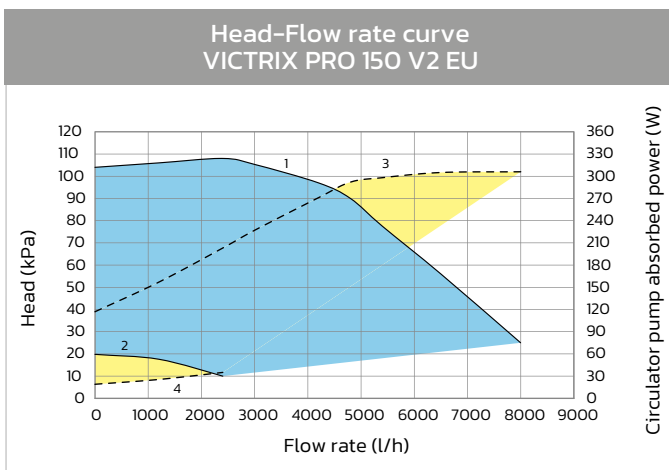
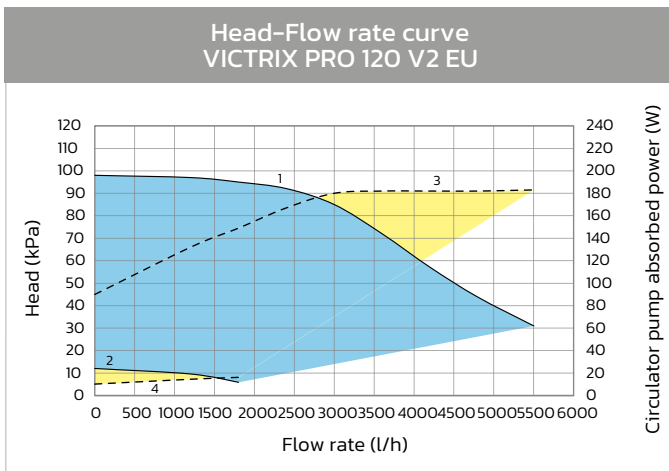
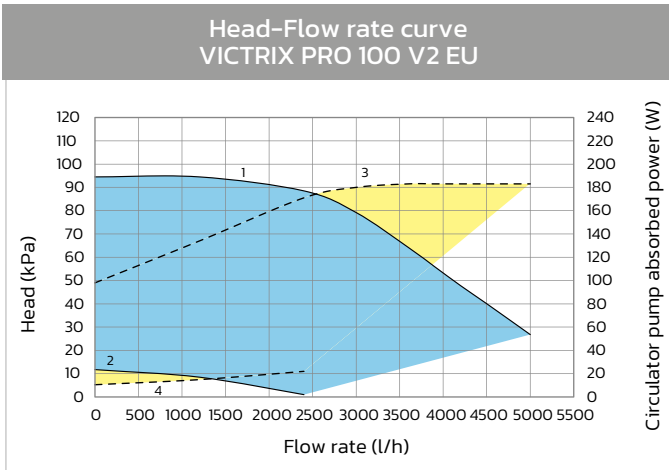

Key

- Available head
- Pump power absorption (dotted area)

1 at 100% speed

2 at 77% speed

3 at 100% speed

4 at 77% speed

A thermoregulation device is a good investment for this range since it significantly increases seasonal efficiency of the heating system.

STAND ALONE INSTALLATION without Cascade and Zones regulator kit

REMOTE CONTROL

Type		Code
<p>This is a modulating control unit that serves to optimize climatic management of the temperature in rooms. It can only be used on systems with a single temperature control.</p> <p>To be combined with Clip-in kit code: 3.034122 for VICTRIX PRO V2</p>	 <p>Dimensions (H x W x D) mm 138 x 90 x 28</p>	3.020358

Clip-in for VICTRIX PRO V2

To be combined with remote control for VICTRIX PRO V2 code 3.020358.		3.034122
----------------------------------------------------------------------	--	----------

CRONO 7

Weekly digital chronothermostat	 <p>Dimensions (H x W x D) mm 103 x 142 x 31</p>	3.021622
---------------------------------	--------------------------------------------------------------------------------------------------------------------------------------------	----------

CRONO 7 WIRELESS

Wireless weekly digital chronothermostat	 <p>Dimensions (H x W x D) mm 103 x 142 x 31</p>	3.021624
	 <p>Dimensions (H x W x D) mm 82 x 105 x 36</p>	

External probe kit

Connected to the boiler board, it optimize the energy consumption by adjusting the delivery temperature. It allows variable temperature functioning		3.015266
-----------------------------------------------------------------------------------------------------------------------------------------------------	--------------------------------------------------------------------------------------	----------

System delivery probe kit

Connected to the boiler board, it measures the delivery temperature after the hydraulic manifold.		3.024245
---------------------------------------------------------------------------------------------------	--	----------

DHW probe kit

Connected to the boiler board, it measures the DHW temperature of a storage tank.		3.025467
-----------------------------------------------------------------------------------	--	----------

TECHNICAL NOTE

If VICTRIX PRO V2 is used without a Cascade and zones regulator and fitted with the system delivery probe kit code 3.024245 (optional) and DHW probe kit code 3.025467 (optional), the boiler electronics will be able to control:

- 1 DHW secondary pump;
- 2 HEATING SYSTEM secondary pumps (for 2 direct zones or 1 direct and 1 mixed)

It is also possible to control **a simple cascade until 5 appliances with uniform power.**

For additional information contact the IMMERGAS Customer Service



CASCADE INSTALLATION with Cascade and Zones regulator kit

Cascade and zones regulator kit

Type		Code
<p>It can manage 3 water distribution zones plus an external storage tank unit and thermal solar for DHW production, both in standalone and cascade configurations. It includes power supply connection for installation on a DIN rail.</p> <p>For the connection you need a Clip-in kit code. 3.034122 for each gas boiler.</p>		3.034119

Clip-in for VICTRIX PRO V2

<p>To be used together with Cascade and Zones regulator kit (1 for each boiler).</p>		3.034122
--------------------------------------------------------------------------------------	--	----------

Expansion kit for Cascade and Zones regulator kit

<p>To be used to manage 1 additional zone (direct or mixed) up to a maximum of 5.</p>		3.034124
---------------------------------------------------------------------------------------	--------------------------------------------------------------------------------------	----------

Zone manager kit

<p>Modulating temperature control, backlit display and remote management of the zone. It works together with the Cascade and Zones regulator kit.</p>		3.034120
-------------------------------------------------------------------------------------------------------------------------------------------------------	---------------------------------------------------------------------------------------	----------

Tools kit for tele-management 2.0 VICTRIX PRO V2

<p>It works together with the Cascade and Zones regulator kit (cod. 3.034119) It includes: LAN network cable 15 m, USB to Ethernet Lan adapter for 1st configuration, dongle Wireless USB for 1st configuration, WLAN dongle for WI-FI connection following the 1st configuration.</p>		3.034121
----------------------------------------------------------------------------------------------------------------------------------------------------------------------------------------------------------------------------------------------------------------------------------------	--	----------

CASCADE INSTALLATION with Cascade and Zones regulator kit**CRONO 7**

Type		Code
Weekly digital chronothermostat	 <p>Dimensions (H x W x D) mm 103 x 142 x 31</p>	3.021622

CRONO 7 WIRELESS

Wireless weekly digital chronothermostat	 <p>Dimensions (H x W x D) mm 103 x 142 x 31</p>  <p>Dimensions (H x W x D) mm 82 x 105 x 26</p>	3.021624
------------------------------------------	--------------------------------------------------------------------------------------------------------------------------------------------------------------------------------------------------------------------------------------------------------------------------------------	----------

Flow probe kit

To be located on the delivery side of the plant, after the hydraulic separator, it allows the cascade and zone regulator to manage the delivery temperature of the plant or of the mixed zones available		3.015267
----------------------------------------------------------------------------------------------------------------------------------------------------------------------------------------------------------	--	----------

Storage tank probe kit

Used to manage the temperature of the water tank unit paired, in boiler rooms, with cascade and zone regulator kit		3.015268
--------------------------------------------------------------------------------------------------------------------	--	----------

Probe kit for PT 1000 solar collector

Used to manage solar plant paired to boiler configurations with cascade and zone regulator kit		3.019374
------------------------------------------------------------------------------------------------	--	----------

External probe kit

Paired with cascade and zone regulator kit, it optimizes energy consumption by adjusting the plant delivery temperature for variable temperature functioning		3.024511
--------------------------------------------------------------------------------------------------------------------------------------------------------------	---------------------------------------------------------------------------------------	----------







FLUE SYSTEM

VICTRIX PRO V2 have a dedicated set of kits for air suction/fume exhaust built to guarantee high resistance to corrosion, ease of installation and functional fit, thanks also to the bayonet fastening system and special sealing gaskets..

FLUE SYSTEMS "GREEN SERIES" FOR VICTRIX PRO V2

Configuration B₂₃ – open chamber, fan assisted

Type		Code
Vertical terminal outlet kit Ø 80 VICTRIX PRO 35/55/60/68/80 V2 (to discharge at roof)		3.034579
Vertical terminal outlet kit Ø 100 VICTRIX PRO 100/120/150 V2 (to discharge at roof)		3.032713
Vertical terminal outlet kit Ø 160 VICTRIX PRO 180 V2 (to discharge at roof) NEW		3.034554
Vertical terminal outlet outdoor kit Ø 80 (stainless steel) VICTRIX PRO 35/55/60/68/80 V2 (for outdoor) length 0.55m Technical note: size is not adjustable		3.024295
Vertical terminal outlet outdoor kit Ø 100 (stainless steel) VICTRIX PRO 100/120/150 V2 (for outdoor) length 1m		3.032714
Vertical terminal outlet outdoor kit Ø 160 (stainless steel) VICTRIX PRO 180 V2 NEW (for outdoor) length 1m Technical note: size is not adjustable		3.034555
Stub-pipe kit Ø80 for air intake for VICTRIX PRO 35/55/60/68/80 V2 with B ₂₃ configuration		3.033759
Stub-pipe kit Ø100 for air intake for VICTRIX PRO 100/120/150 V2 with B ₂₃ configuration		3.033760
Stub-pipe kit Ø160 for air intake for VICTRIX PRO 180 V2 with NEW B ₂₃ configuration		3.034565
Horizontal kit Ø 80 VICTRIX PRO 35/55/60/68/80 V2 (to discharge in the chimney)		3.015254
Horizontal kit Ø 100 VICTRIX PRO 100/120/150 V2 (to discharge in the chimney)		3.032715
Horizontal kit Ø 160 VICTRIX PRO 180 V2 (to discharge in the chimney) NEW		3.034556
Horizontal kit Ø 80 VICTRIX PRO 35/55/60/68/80 V2 (to discharge horizontally)		3.015255
Horizontal kit Ø 100 VICTRIX PRO 100/120/150 V2 (to discharge horizontally)		3.032716
Horizontal kit Ø 160 VICTRIX PRO 180 V2 (to discharge horizontally) NEW		3.034557





FLUE SYSTEMS "GREEN SERIES" FOR VICTRIX PRO V2

Configuration B₂₃ – open chamber, fan assisted

Extension pipes kit

Type		Code
4 extension pipes Ø 80 kit VICTRIX PRO 35/55/60/68/80 V2 0,5 m long		3.014642
4 extension pipes Ø 100 VICTRIX PRO 100/120/150 V2 0,5 m long		3.031132
4 extension pipes Ø 80 VICTRIX PRO 35/55/60/68/80 V2 1 m long		3.012088
4 extension pipes Ø 100 VICTRIX PRO 100/120/150 V2 1 m long		3.031373
1 extension pipe Ø 80 VICTRIX PRO 35/55/60/68/80 V2 2 m long		3.016837
4 extension pipes Ø 100 VICTRIX PRO 100/120/150 V2 2 m long		3.032319
4 extension pipes Ø 160 kit VICTRIX PRO 180 V2 0,5 m long NEW		3.034559
4 extension pipes Ø 160 kit VICTRIX PRO 180 V2 1 m long NEW		3.034560
4 extension pipes Ø 160 kit VICTRIX PRO 180 V2 2 m long NEW		3.034561

Bends kit

45° bend Ø 80 kit VICTRIX PRO 35/55/60/68/80 V2		3.012092
45° bend Ø 100 kit VICTRIX PRO 100/120/150 V2		3.032195
45° bend Ø 160 kit VICTRIX PRO 180 V2 NEW		3.034562
4x90° bend Ø 80 kit VICTRIX PRO 35/55/60/68/80 V2		3.012091
4x87° bend Ø 100 kit VICTRIX PRO 100/120/150 V2		3.032731
4x90° bend Ø 160 kit VICTRIX PRO 180 V2 NEW		3.034563

Gasket kits DN100

4x gasket kits for Victrix Pro 100/120/150 V2	3.032732
-----------------------------------------------	----------

Clapet valve kit for outdoor installation

The kits are necessary for installation with stainless steel flue manifold not supplied by Immergas in combination with stub-pipe kit for air intake

Clapet valve kit Ø 80 in stainless steel VICTRIX PRO 35/55/60/68/80 V2		3.033715
Clapet valve kit Ø 125 in stainless steel VICTRIX PRO 100/120/150 V2		3.033716

Cover kit



Protection kit IPX5D for outdoor installation. With this kit it is not necessary to add the stub-pipe kit B₂₃ for air intake.

Cover kit IPX5D VICTRIX PRO 35/55/60/68/80 V2		3.033670
Cover kit IPX5D VICTRIX PRO 100/120 V2		3.033671
Cover kit IPX5D VICTRIX PRO 150 V2		3.033672
Cover kit IPX5D VICTRIX PRO 180 V2 NEW		3.033689



FLUE SYSTEMS "GREEN SERIES" FOR VICTRIX PRO V2

Configuration C – sealed chamber, fan assisted

Type		Code
Horizontal concentric kit Ø 80/125* for VICTRIX PRO 35/55/60/68/80 V2		3.033785
Horizontal concentric kit Ø 110/160* for VICTRIX PRO 100/120/150 V2		3.033789
Vertical concentric kit Ø 80/125 for VICTRIX PRO 35/55/60/68/80 V2 (black coloured, with converse for pitched roofs)		3.033786
Vertical concentric kit Ø 110/160 for VICTRIX PRO 100/120/150 V2 (black coloured, with converse for pitched roofs)		3.033790
Flashing Kit Ø 80/125 for flat roof for VICTRIX PRO 35/55/60/68/80 V2		3.015249
Twin pipes complete kit Ø 80/80 for VICTRIX PRO 35/55/60/68/80 V2 (color RAL 9010)		3.012002
Twin pipes complete kit Ø 100/100 for VICTRIX PRO 100/120/150 V2 (color RAL 9010)		3.032717
Twin pipes complete kit Ø 160/160 for VICTRIX PRO 180 V2 NEW		3.035122
Extension pipe 1 m long Ø 80/125 for VICTRIX PRO 35/55/60/68/80 V2		3.018667
Extension pipe 1 m long Ø 110/160 for VICTRIX PRO 100/120/150 V2		3.031397
Extension pipe 2 m long Ø 80/125 for VICTRIX PRO 35/55/60/68/80 V2		3.015246
Extension pipe 2 m long Ø 110/160 for VICTRIX PRO 100/120/150 V2		3.031398
2 x 45° bend kits Ø 80/125 for VICTRIX PRO 35/55/60/68/80 V2		3.015248
45° Bend kit Ø 110/160 for VICTRIX PRO 100/120/150 V2		3.031395
87° Bend kit Ø 80/125° for VICTRIX PRO 35/55/60/68/80 V2		3.015247
87° Bend kit Ø 110/160 for VICTRIX PRO 100/120/150 V2		3.031396

*Double check if flue discharge on the wall is allowed by current regulations.

Gasket kit

Gasket kits 10 pcs. Ø 80 Ø 80/125	3.015343
Gasket kits 10 pcs. Ø 80 Ø 80	3.015378
Gasket kits 4 pcs. Ø 100	3.032732
Gasket kit Ø 110	3.015344
Gasket kit Ø 125	3.015345

The ducting solution allows reuse the internal space not only of existing chimneys, but also technical compartments, to be understood as those compartments with vertical development, without structural continuity, having closed perimeter and used for the containment of technical services of the building.

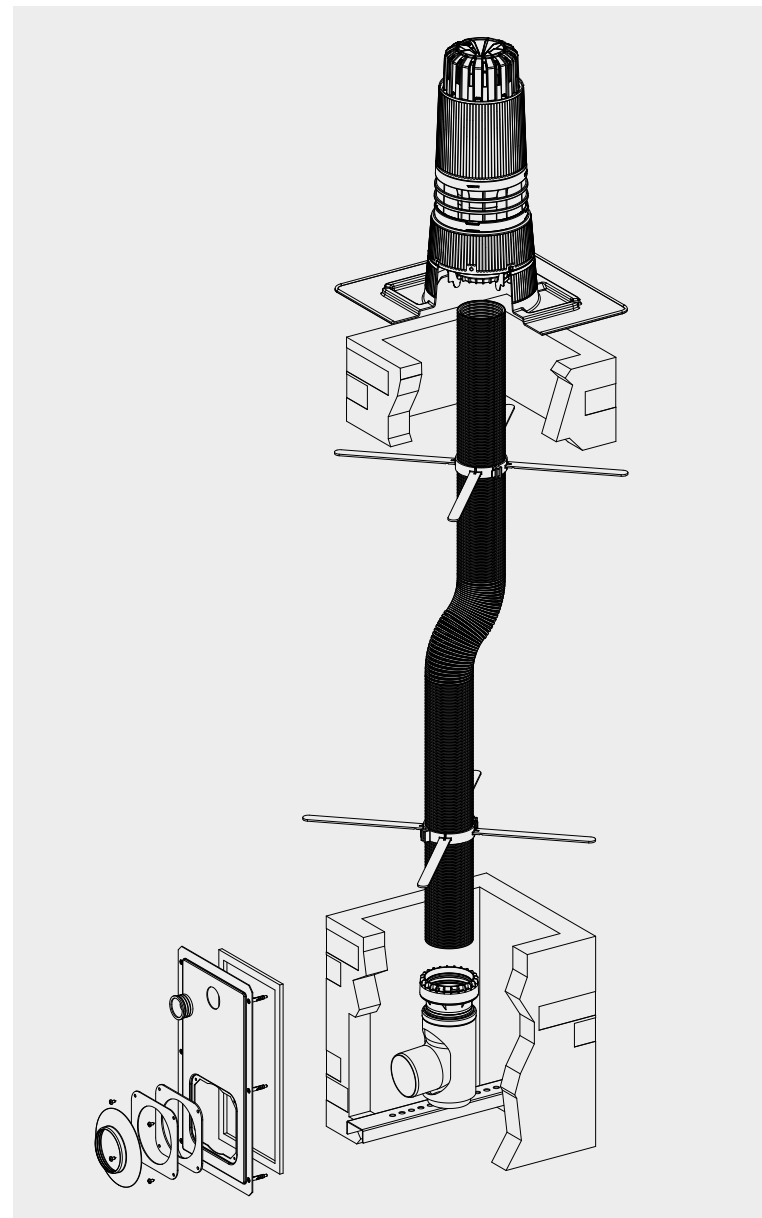

The maximum allowed pipe lengths are as follows (for proper installation, please refer to the the system manuals):

- VICTRIX PRO 35 V2 maximum length 12 m
- VICTRIX PRO 55 V2 maximum length 12 m
- VICTRIX PRO 60 V2 maximum length 8 m
- VICTRIX PRO 68 V2 maximum length 8 m
- VICTRIX PRO 80 V2 maximum length 8 m

This length is obtained by considering

- 1 90° bend Ø 80 mm for boiler connection (outlet)
- 1 m of pipe Ø 80 mm in outlet two changes in direction of the vertical section
- the Ø 80 mm bend
- the Ø 80/125 vertical kit for ducting.

The system **can be paired with a single appliance.**

EC Certificate according to UNI EN 14471



FLUE SYSTEMS "GREEN SERIES" FOR VICTRIX PRO V2



Ø 80 mm flexible ducting system

Type		Code
Flexible ducting kit Ø 80 mm, L=12 m + 4 centering spacers		3.027875
Support bend kit Ø 80 mm 87° and flexible ducting adapter Ø 80		3.027873
Support bend kit Ø 80 mm 70° M and flexible ducting adapter Ø 80		3.027874
Vertical outlet kit Ø 80/125 for flexible ducting Ø 80		3.027876
Chimney hole closing panel kit		3.012008
Flexible/flexible adapter kit for flexible ducting Ø 80		3.027877

EXHAUST MANIFOLD VICTRIX PRO V2

Installation in boiler room VICTRIX PRO 35-150 V2

With installations in boiler room, using up to 5 VICTRIX PRO V2 in the battery, in configuration B₂₃ (open chamber fan assisted), Immergas supplies special exhaust manifolds in PP equipped with flue lock (mechanical shutters), to prevent backflow of combustion products through the other non-functioning boilers. The system is modular: there is an exhaust manifold kit for two boilers and one for additional boilers. Configuration not applied to version VICTRIX PRO 180 V2.



Type		Code
Exhaust manifold kit VICTRIX PRO 35/55/60/68/80 V2 Ø 160 with flue lock DN 80 for exhaust connection of two boilers in cascade		3.034257
Exhaust manifold kit VICTRIX PRO 100/120/150V2 Ø 200 with flue lock DN 125 for exhaust connection of two boilers in cascade.		3.034259
Additional exhaust manifold kit VICTRIX PRO 35/55/60/68/80 V2 Ø 160 with flue lock DN 80 for connection of an additional boiler		3.034258
Additional exhaust manifold kit VICTRIX PRO 100/120/150 V2 Ø 200 with flue lock DN 125 for connection of an additional boiler		3.034260
Additional exhaust manifold kit Ø 250 with flue lock DN 125 for 4 VICTRIX PRO 150 V2		3.034261
Additional exhaust manifold kit Ø 250 with flue lock DN 125 for 5 VICTRIX PRO 150 V2		3.034262
Extension pipe Ø 160 kit 0,5 m long for flue manifold		
Extension pipe Ø 200 kit 0,5 m long for flue manifold		3.024663
Extension pipe Ø 160 kit 1 m long for flue manifold		3.024516
Extension pipe Ø 200 kit 1 m long for flue manifold		3.024662
Extension pipe Ø 250 kit 1 m long for flue manifold		3.024668
87° bend kit Ø 160 for flue manifold		3.024517
87° bend kit Ø 200 for flue manifold		3.024665
87° bend kit Ø 250 for flue manifold		3.024670
2 x 45° bend kit Ø 160 for flue manifold		3.024518
2 x 45° bend kit Ø 200 for flue manifold		3.024664
2 x 45° bend kit Ø 250 for flue manifold		3.024669
Stub-pipe kit Ø80 for air intake for VICTRIX PRO 35/55/60/68/80 V2 with B ₂₃ configuration		3.033759
Stub-pipe kit Ø100 for air intake for VICTRIX PRO 100/120/150 V2 with B ₂₃ configuration		3.033760





OPTION KITS

Within our range it is possible to find a wide option of accessories for the system. The use of original kits ensures quality and reliability of the products.

CABINET INSTALLATION VICTRIX PRO 35-150 V2







Type		Code
<p>VICTRIX PRO cabinet kit it can be installed outdoor. It includes 4 support feet that ensure stable installation and its handling by forklift truck or transpallet to be positioned below the cabinet frame. Alternatively, you can move the cabinet by means of 4 eyebolts in the upper part. The cabinet has a door that can be opened by 180 inclusive of lock.</p>		3.033680
<p>Hydraulic manifold and safety kit for VICTRIX PRO V2 cabinet for single and cascade installation. The kit includes hydraulic manifold DN 100 with safety kit and condensate discharge manifold DN 50. The installer has to realise gas manifold based on design.</p>		3.033681

FREE-STANDING INSTALLATION VICTRIX PRO 35-150 V2

<p>"Free standing" support frame kit VICTRIX PRO 35/55/60/68/80 V2 designed to resolve installation situations in which the wall of the boiler room is not usable. With this modular construction, it is necessary to order a kit for every boiler installed. Approved also for installation outside the building.</p>		3.032347
<p>"Free standing" support frame kit VICTRIX PRO 100/120/150 V2 designed to resolve installation situations in which the wall of the boiler room is not usable. With this modular construction, it is necessary to order a kit for every boiler installed. Approved also for installation outside the building.</p>		3.033686



HYDRAULIC OPTIONAL FOR SINGLE INSTALLATION







Type		Code
<p>Safety kit single boiler the kit includes thermometer, thermometer holder, lock, thermostat with manual reset, connection tap for pressure gauge, manual reset pressure switch, gas intercepting valve trap, expansion vessel connection and pressure switch for minimum pressure. Insulation as standard</p>		3.023949
<p>Three-way valve kit connection to a separate storage tank the kit includes the storage tank probe. The power supply is 230 Vac. Insulation as standard</p>		3.023950
<p>Hydraulic manifold kit for VICTRIX PRO 35/55/60/68/80 V2 specially sized for large thermal systems with high water content. Equipped with sludge collection filter on the return pipe. Insulation as standard</p>		3.023951
<p>Hydraulic manifold kit for VICTRIX PRO 100/120/150/180 V2 specially sized for large thermal systems with high water content. Equipped with sludge collection filter on the return pipe. Insulation as standard</p>		3.023952
<p>IPX4D protection box kit for single boiler safety kit</p>		3.024028
<p>Adapter kit VICTRIX PRO 35/55/60/68/80 V2 for replacement of VICTRIX 50 and 75 versions in single wall unit configuration</p>		3.023966
<p>Anti freeze protection kit -15 °C</p>		3.034125
<p>Condensate neutralizer until 80 kW necessary to neutralize the acidity of the condensation. Inclusive of granulate.</p>		3.033687
<p>Condensate neutralizer until 180 kW necessary to neutralize the acidity of the condensation. Inclusive of granulate</p>		3.033688
<p>Granulate for condensate neutralizer until 180 kW</p>		3.034920
<p>Condensate discharge pump kit To be used in case of opposite slope between siphon and discharge. It can only be installed inside the building and outside the appliance</p>		3.020002
<p>Magnetic dirt separator kit for single installation For installation both on right and left side</p>		3.033673
<p>Plate heat exchanger kit for single installation on the right side of VICTRIX PRO 35/55/80 V2 The kit includes connecting pipes, air vent, discharge tap, filling taps and connection to expansion vessel</p>		3.033676
<p>Plate heat exchanger kit for single installation on the right side of VICTRIX PRO 100/120/150/180 V2 The kit includes connecting pipes, air vent, discharge tap, filling taps and connection to expansion vessel</p>		3.033677

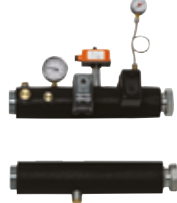

OPTION KITS

HYDRAULIC OPTIONAL FOR CASCADE INSTALLATION

The following hydraulic accessories are supplied as optionals for completion of cascade installations from 2 up to 5 VICTRIX PRO V2

Type		Code
<p>Hydraulic manifold kit G 2 ½" for 2 VICTRIX PRO 35/55/60/68/80 V2 in cascade the kit includes a 2-way valves, a 3-way interception valve and a non-return valve for each generator. Insulation as standard.</p>		3.032338
<p>Hydraulic manifold kit G 2 ½" for additional VICTRIX PRO 35/55/60/68/80 V2 in cascade in combination with kit 3.032338, it serves to connect from 3 to 5 VICTRIX PRO V2 boilers in cascade installation (one kit required for each additional boiler); includes a 2-way interception valve, a 3-way interception valve and a non-return valve. Insulation as standard</p>		3.033669
<p>Safety kit G 2" ½ for VICTRIX PRO 35/55/60/68/80 V2 in cascade the kit includes thermometer, thermometer holder, lock, thermostat with manual reset, connection tap for pressure gauge, manual reset pressure switch, gas intercepting valve trap, expansion vessel connection and pressure switch for minimum pressure. Insulation as standard.</p>		3.023955
<p>Hydraulic manifold kit DN 100 for 2 VICTRIX PRO 100/120/150 V2 in cascade the kit includes a 2 way interception valve, a 3-way interception valve and a non-return valve for each generator. Insulation as standard</p>		3.033667
<p>Hydraulic manifold kit DN 100 for additional VICTRIX PRO 100/120/150 V2 in cascade in combination with kit 3.033667 serves to connect from 3 to 5 VICTRIX PRO V2 boilers in cascade installation (one kit required for each additional boiler); includes a 2-way interception valve, a 3-way interception valve and a non-return valve. Insulation as standard</p>		3.033668
<p>Hydraulic manifold kit DN 100 for 2 VICTRIX PRO 180 V2 in battery NEW the kit includes a 2 way interception valve, a 3-way interception valve and a non-return valve for each generator. Insulation as standard.</p>		3.034938
<p>Hydraulic manifold kit DN 100 for additional VICTRIX PRO 180 V2 in cascade NEW in combination with kit 3.034938 it serves to connect from 3 to 5 VICTRIX PRO V2 boilers in cascade installation (one kit required for each additional boiler); includes a 2-way interception valve, a 3-way interception valve and a non-return valve. Insulation as standard.</p>		3.034939
<p>Safety kit DN 100 for VICTRIX PRO 100/120/150/180 V2 in cascade the kit includes thermometer, thermometer holder, lock, thermostat with manual reset, connection tap for pressure gauge, manual reset pressure switch, gas intercepting valve trap, expansion vessel connection and pressure switch for minimum pressure. Insulation as standard</p>		3.023961
<p>IPX4D protection box kit for boiler in cascade safety kit</p>		3.024038



HYDRAULIC OPTIONAL FOR CASCADE INSTALLATION

The following hydraulic accessories are supplied as optionals for completion of cascade installations from 2 up to 5 VICTRIX PRO V2

Type		Code
<p>Hydraulic separator for 100 kW installations separator with G2 ½" threaded connectors. Insulation as standard.</p>		3.020839
<p>Hydraulic separator for 200 kW installations separator with G2 ½" threaded connectors. Insulation as standard.</p>		3.021377
<p>Hydraulic separator for 400 kW installations separator with G2 ½" threaded connectors on boiler side – DN 100 on system side. Insulation as standard.</p>		3.021378
<p>Hydraulic separator for 350 kW installations separator with flanged connectors – DN 100. Insulation as standard.</p>		3.023965
<p>Hydraulic separator for 600 kW installations separator with flanged connectors – DN 100. Insulation as standard.</p>		3.023962
<p>Anti freeze protection kit -15 °C One kit for every boiler</p>		3.034125
<p>Condensate neutralizer until 80 kW necessary to neutralize the acidity of the condensation. Inclusive of granulate.</p>		3.033687
<p>Condensate neutralizer until 180 kW necessary to neutralize the acidity of the condensation. Inclusive of granulate.</p>		3.033688
<p>Condensate neutralizer until 1500 kW necessary to neutralize the acidity of the condensation. Inclusive of granulate.</p>		3.023662
<p>Granulate for condensate neutralizer until 180 kW</p>		3.034920
<p>Granulate for condensate neutralizer until 1.500 kW (25 kg).</p>		3.023663
<p>Magnetic dirt separator kit for VICTRIX PRO 35/55/60/68/80 V2 in cascade The kit includes connection manifolds* and support</p>		3.033674
<p>Magnetic dirt separator kit for VICTRIX PRO 100/120/150/180 V2 in cascade The kit includes connection manifolds* and support.</p>		3.033675
<p>Plate heat exchanger kit for cascade installation on the right side of VICTRIX PRO 35/55/60/68/80 V2 The kit includes connecting pipes, air vent, discharge tap, filling taps and connection to expansion vessel.</p>		3.033678
<p>Plate heat exchanger kit for cascade installation on the right side of VICTRIX PRO 100/120/150/180 V2 The kit includes connecting pipes, air vent, discharge tap, filling taps and connection to expansion vessel</p>		3.033679

*Designed for installation with Inail Kit. For the pairing above dirt separator or heat exchanger dedicated kit it is necessary to realise pipework spacing adaptation not supplied by immergas



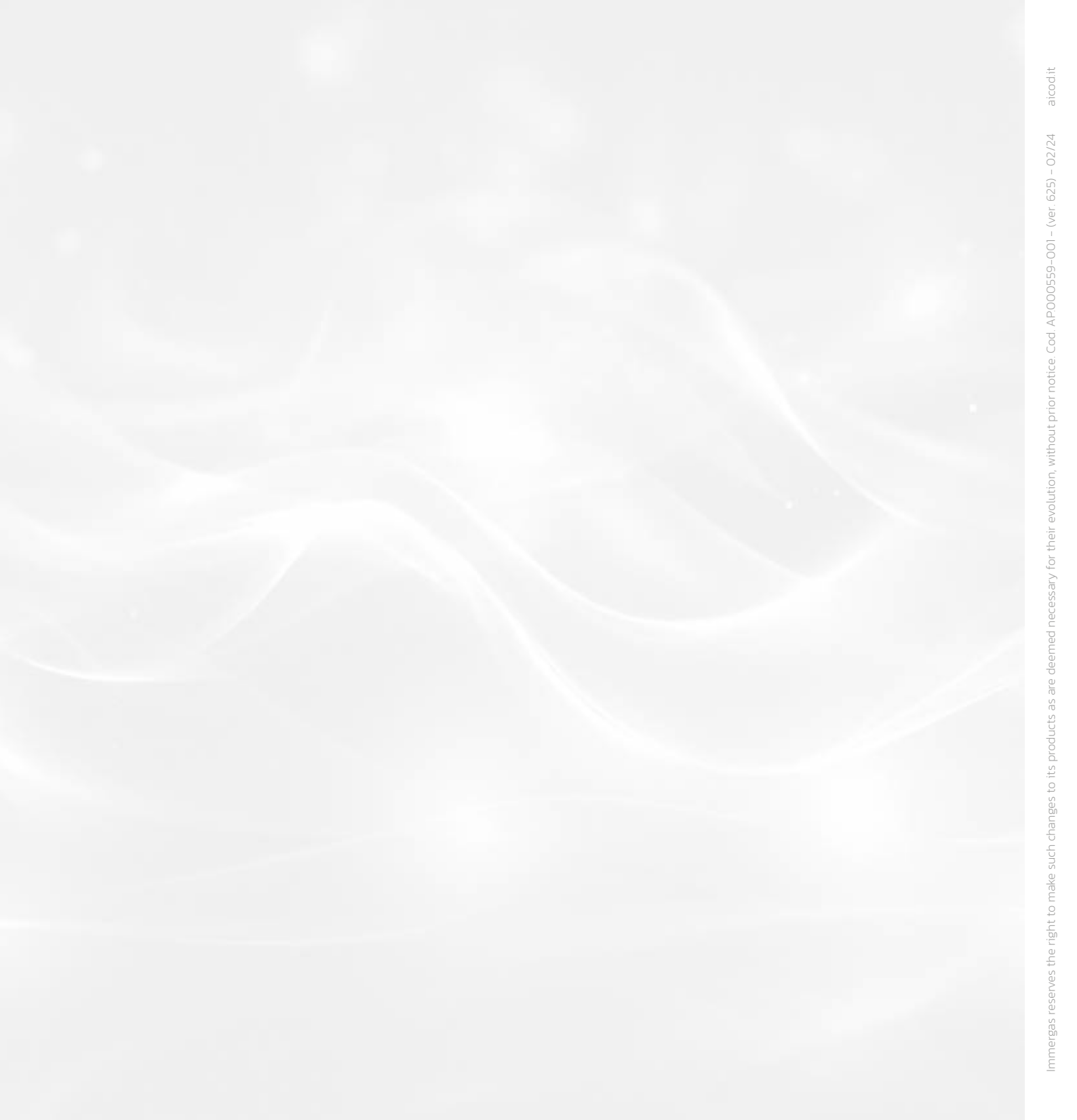

Immergas S.p.a.

42041 Brescello (RE) - Italy

T. 0522.689011



immergas.com



	IMMERGAS IMMERGAS SPA - ITALY CERTIFIED COMPANY UNI EN ISO 9001:2015
Design, manufacture and post-sale assistance of gas boilers, gas water heaters and related accessories	