



Washbasin taps. By SCHELL.

Valve technology: Made in Olpe.

Almost 90 years ago, Hubert Schell began production of angle valves, laying the foundation for a success story that continues to the present day. And, because we never stop striving to make things better, we are still the leading integrated provider of fittings for public, semi-public and commercial buildings.

With our intelligent valve technology and uncompromising approach to quality, this is a market where we set the standards when it comes to hygiene and the sustainable use of water. Our fittings for washbasins, showers, WCs and urinals combine an appealing design with high-quality workmanship and sophisticated control technology. A wide range of models is available to ensure the highest demands can be met in any washbasin, shower or WC facility.

From an initial focus on angle valves, our portfolio has developed over the years into a comprehensive range of

products for connecting fittings, radiators and household appliances – often intelligently combined with extra features and always of the first quality in terms of materials and finish.

We are still headquartered in our original home town of Olpe and our quality is, as ever, 'Made in Germany'. As a family-run company in its third generation, we have remained true to our core values. And with success: over the last few years, our stable domestic growth has been matched by a substantial increase in export business.

In the heart of Germany

Olpe is a town in the south-east of North Rhine-Westphalia. This is the place we at SCHELL call home.



Production building with offices and training centre



Production building and logistics centre

Contents

| | | |
|-------------------|-------------------------------------|----|
| Advantages | Features | 4 |
| | Hygiene | 6 |
| | Sustainability | 8 |
| | Technologies | 10 |
| | SCHELL SWS and SSC | 12 |
| | Design | 14 |
| | | |
| Products | Standard taps | |
| | Contact-free with infrared sensor . | 18 |
| | Manual self-closing | 20 |
| | With single lever | 21 |
| | Open/Closed | 21 |
| | | |
| | Exposed taps | |
| | Contact-free with infrared sensor . | 24 |
| | Electronic self-closing | 24 |
| | Manual self-closing | 24 |
| | With arm lever | 25 |
| | With single lever | 25 |
| | Open/Closed | 25 |
| | | |
| | Wall-mounted draw-off taps | |
| | Contact-free with infrared sensor . | 27 |
| | Manual self-closing | 27 |
| | | |
| Service | Overview for washbasin taps | 28 |
| | References | 30 |

More than just a tap: a wellspring of wellbeing.





The washbasin is a focal point that is used by everyone. With our taps, you not only make a positive difference to your hygiene standards but also to how your washroom is perceived, to how people feel when leaving it and to your levels of water consumption.

Public buildings need to meet a wide range of requirements: while they must be functional and efficient to run. They increasingly need to be representative, too – as part of your image. As a place used by everyone, sanitary facilities play not just a necessary but also an important role. In any washroom, you can't miss the washbasin - although you would if it was absent.

As a specialist for taps and fittings in public sanitary facilities, we know – and fulfil – the various demands placed on washbasin taps. Just some of the key features of our washbasin taps:

- Technology that ensures continuous, high-quality drinking water hygiene
- Easy-clean shapes and surfaces
- High-end and highly durable product quality
- Hygienic, user-friendly operation
- Economical water consumption
- A wide choice of designs to match any architecture

With the possibility of being integrated into our SCHELL SWS Watermanagement System our electronic wash basin fittings make your washroom fit for the future.

A place with a history

Public sanitary facilities are not a modern invention. People have been concerned about hygiene for much longer: its origins lie in antiquity. After the Greek and then the Roman empire, however, public latrines also became a thing of the past.

Only in the 19th century was the importance of hygiene for health once again recognised, ushering in a renaissance for public sanitary facilities. Today, a public building's sanitary facilities are often its invisible 'visiting card'.

We take responsibility for your health: Keeping you fit for the future.

The building operating company is also responsible for the soundness of its drinking water hygiene. In the event of problems, the installer can be held liable. Of proper installation and equipment and the avoidance of unused pipelines reduce the formation of microorganism. Ideally, this minimises the risk of the transmission of pathogenic organisms.

In particular our taps with infrared sensors and contact-free operation offer a maximum level for users. In addition, all of our taps are also designed to be particularly easy to clean. The high-quality chrome-plated surface is also ideal in terms of hygiene.

Inside, all materials are approved for drinking water use to ensure first-class water quality. Many of our washbasin taps are also equipped with technologies that enable to programme stagnation flushes. This minimises the formation of microorganisms during longer periods of non-use. In the event of a case of Legionella being detected, thermal disinfection offers the option of eradicating dangerous microorganisms like Legionella bacteria.

Public sanitary facilities pose special challenges in relation to hygiene, materials and water consumption.



Users assume drinking water will be of a high quality.

In Germany, around 85 % of the population consider drinking water quality to be 'good' or 'very good' (2014 survey by the Institute of Empirical Social and Communication Research (IESK) for the Association of Local Public Utilities (VKU)). This level of trust in drinking water quality stems from the strict monitoring performed by the water utilities. However, water utilities are only responsible up to the delivery to the house installation. From here onwards, our products are an excellent choice.

Risks from rod-shaped bacteria: a WHO report states that approx. 80 % of all infectious diseases are transmitted by the hands.





We were already sustainable before people even started using the word.

Anyone who handles water on a daily basis knows how valuable this resource is. Public buildings in particular – the natural habitat for our washbasin taps – pose specific kinds of challenges. But with products from SCHELL, valuable benefits are achievable for the environment, users and building owners.

This is why we make every effort to ensure that our washbasin taps do not merely meet the very highest hygiene standards but also achieve the lowest possible levels of water consumption. Every day, intelligent technologies and a technically sophisticated product design help to save water while it is being used. Another benefit is that with mixed-water taps, reduced water consumption also means less use of hot water – and therefore less use of energy.



SCHELL awarded maximum ratings internationally for saving water



SCHELL is a member of EUUnited Valves, the European fittings association



More information at: www.blue-responsibility.com



More information at: <http://www.well-online.eu>



With a self-closing tap, water savings of up to 56 % are possible. A contact-free tap can even save as much as 62 %.

Our taps support a sustainable and environmentally-friendly approach to building operation by reducing water and energy consumption, and offering a long usage life. This is also relevant for achieving building certifications – according to the LEED standard, for example. To provide optimal guidance for our customers, selected SCHELL fittings are classified according to WELL, the rating system published by EUnited Valves.



There is only one reason for our technologies: maximum benefit.

When developing our technologies, we don't ask: "What can we do?" but "What can we do – for you?" The functionality offered by a washbasin tap determines safety and convenience during installation and operation. This is not a place to make compromises. And, since requirements vary, we offer four different kinds of actuation mechanisms.

Self-closing operation with CVD touch electronics

The tap is actuated by touching the sensor and then closes independently, according to the individually configured flow time. The tap can also be closed more quickly by tapping the sensor again manually.

- Water savings of up to 56 %
- For cold and mixed water or with a thermostat
- Programmable stagnation flush
- SWS-capable

Self-closing operation with cartridge technology

Different approach – similar effect: After actuation, the taps close independently in accordance with the configured flow time, and save water.

- Water savings of up to 56 %
- For cold and mixed water
- Vandal-resistant all-metal construction with plastic cartridge

Manual operation

Our convenient manual operation offers very easy, individualised control.

- High level of user comfort
- For mixed water or with a thermostat or cold water
- Special designs available (e.g. for healthcare)



**Contact-free operation
with infrared sensor**

Our taps with an infrared sensor are operated without any contact. Water flows only when it is really needed.

- Maximum hygiene
- Simple, convenient operation for almost all users
- Water savings of up to 62 %
- For cold and mixed water
- Programmable stagnation flushes and thermal disinfection
- SWS-capable



SCHELL system solutions: the future is digital. Even in public sanitary facilities.

The SCHELL system solutions herald a new era for facility management work in public buildings. From the parameterisation of individual electronic taps to the central, server-based control system for all installations, efficient user comfort is assured at all times with digital solutions from SCHELL.

SCHELL Water Management System SWS

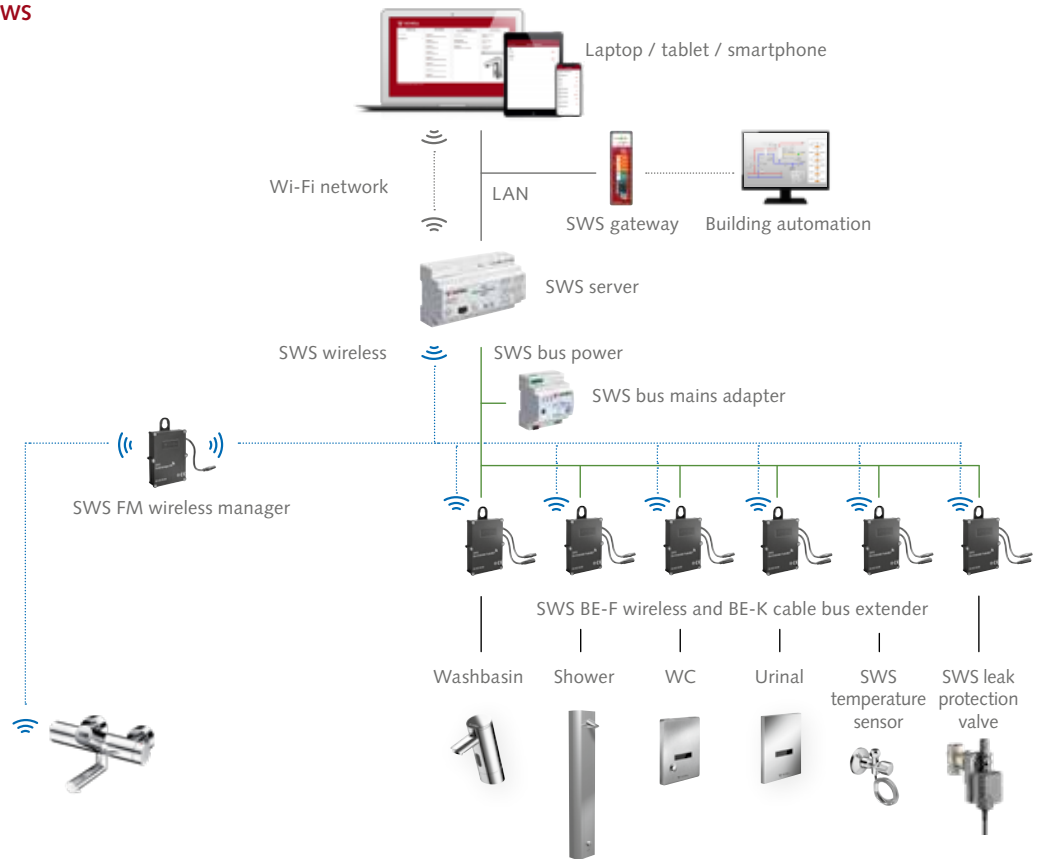

SCHELL Single Control SSC Bluetooth® module

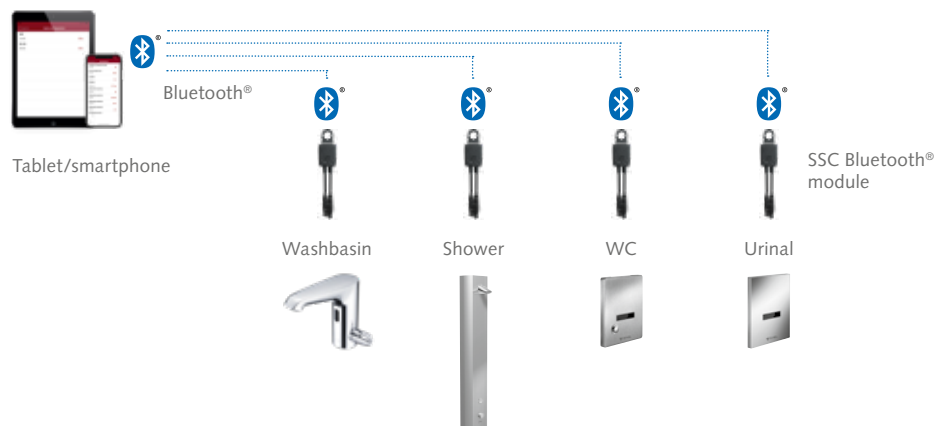

SCHELL Water Management System SWS

The water management system is designed for maintaining water quality in larger buildings with a large number of taps – and with sensors as required. In this system, all electronic taps and sensors are networked using a wired or wireless network and managed systematically by one or more servers.



SCHELL Single Control SSC Bluetooth® module

The SSC Bluetooth® module has been designed for use in buildings with only a few electronic taps. It enables wireless communication between a smartphone and a tap. The module can be either permanently or temporarily connected to the tap.



Our washbasin taps are always popular. And not just because of the good design.

We believe that good design makes a clear statement about the requirements that need to be met. For our taps, these requirements include optimum hygiene, rugged construction and a first-class fit-out for public, semi-public and commercial sanitary facilities.

We work with leading designers to develop for each tap's a unique style. The result is a design that is straight forward and functional. It supports a modern architectural language, upgrades washrooms and ensures safe use and efficient operation.

Outstanding!

The regular awarding of certificates and prizes shows that we're not the only ones who believe in our design philosophy. It is especially gratifying that these accolades are awarded for both the quality and the design of our products.



reddot design award
winner 2004



DESIGN PLUS





Standard taps

Fulfilling the need for a modern look with timeless functionality.





Contact-free with infrared sensor: Touches the senses – without any contact.

Our standard taps with contact-free actuation transform functionality into convenience, hygiene into safety and design into appreciation.



Electronic washbasin tap
XERIS E

- 3 sizes
- Mains supply or battery operation
- High-pressure mixed or cold water
- SWS-capable



Electronic washbasin tap
XERIS E-T

- With thermostat and scalding protection
- 3 sizes
- Mains supply or battery operation
- High-pressure mixed water
- SWS-capable

XERIS

The tap family XERIS beautifully enhances any washbasin in washroom facilities in museums and restaurants, or in office and school buildings. The tap combines optimum levels of hygiene with first-class design and long-lasting functionality. Select from a range of sizes and heights, as well as various options for temperature control. The XERIS E-T, a sensor tap with thermostat and the winner of several design awards, truly leaves nothing to be desired in a product offering first-class hygiene, safety and convenience while meeting the most sophisticated stylistic sensibilities.



Other tap families

Our aim is to achieve perfect harmony with modern architecture. We offer therefore a wide range of tap families. Featuring a number of different designs suitable for a wide range of applications – from washrooms in offices, restaurants and museums to sanitary facilities in schools, nursery schools, sports centres, stadiums and service stations. Common to them all is a focus on first-class hygiene and durability.



Electronic washbasin tap
PURIS E

- Mains supply or battery operation
- High-pressure mixed or cold water
- Low-pressure mixed water
- SWS-capable



Electronic washbasin tap
VENUS E

- Mains supply or battery operation
- High-pressure mixed or cold water
- Low-pressure mixed water
- SWS-capable



Electronic washbasin tap
CELIS E

- Mains supply or battery operation
- High-pressure mixed or cold water
- SWS-capable



Electronic washbasin tap
MODUS E

- Mains supply or battery operation
- High-pressure mixed or cold water

Manual self-closing

Self-closing
washbasin tap
XERIS SC-M

- 2 sizes
- High-pressure mixed or cold water
- With temperature regulator



Self-closing
washbasin tap
PURIS SC

- High-pressure mixed or cold water
- With temperature regulator



Self-closing
washbasin tap
PETIT SC

- High-pressure mixed or cold water
- With temperature regulator

Especially in semi-public sanitary rooms – for example in gastronomy and administration – fittings with manual control and linear design create value.



With single lever



Washbasin
single-lever mixer
MODUS EH

- High-pressure mixed or cold water

Open/Closed



Washbasin tap
Open/Closed
MODUS K

- High-pressure cold water

Wall-mounted washbasin taps.
Optimum, hygiene, in a wide range of styles.





VITUS

Our VITUS range offers a unique concept of fittings. The special feature is its modularity. VITUS offers a wide range of separate designs – for mixed water or with a thermostat, with manual, self-closing or electronic actuation, with technological systems for hygiene flushes, and with three different draw-off tap lengths.

Contact-free with infrared sensor

Electronic washbasin tap
VITUS VW-E-T

- Battery operation
- High-pressure mixed water
- With thermostat
- Manual thermal disinfection optionally available
- SWS-capable



Electronic self-closing with CVD button

Self-closing washbasin tap
VITUS VW-C-T

- Battery operation
- High-pressure mixed water
- With thermostat
- Manual thermal disinfection optionally available
- SWS-capable



Manual self-closing

Self-closing washbasin tap
VITUS VW-SC

- High-pressure mixed water
- Thermostat optionally available
- Manual thermal disinfection optionally available



Manual self-closing

Self-closing wall-mounted washbasin tap
PETITI SC

- High-pressure cold water
- Isolating valve optionally available



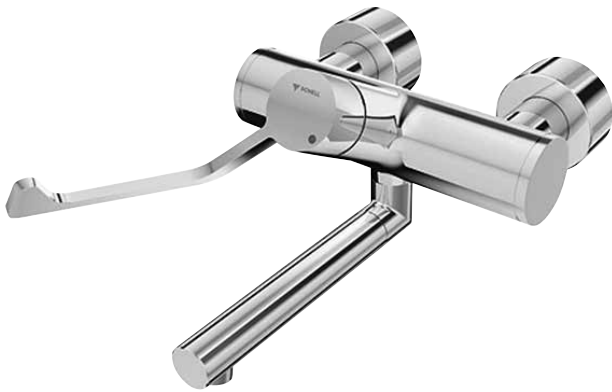

With arm lever

Wall-mounted washbasin tap
VITUS VW-AH

- High-pressure mixed water
- Thermostat optionally available
- Manual thermal disinfection optionally available



We have focused in particular on user and drinking water hygiene. This means VITUS is also ideal for use in healthcare facilities.

With single lever

Wall-mounted washbasin tap
VITUS VW-EH

- High-pressure mixed water
- Manual thermal disinfection optionally available



Open/Closed

Wall-mounted washbasin tap
VITUS VW Open/Closed

- High-pressure mixed water
- With thermostat
- Manual thermal disinfection optionally available



Concealed washbasin taps.
The facility-neutral tap range
with a space-saving footprint.



Contact-free with infrared sensor



Electronic concealed
washbasin tap
LINUS W-E

- Mains or battery operation
- High-pressure mixed or cold water
- 3 different draw-off tap lengths
- Front panel chrome-plated brass
- SWS-ready

LINUS

LINUS is a complete concealed washbasin tap series that offers a wide range of design variants. As a result showers and washrooms can be equipped in a uniform style, for example. The robust design and water-saving technologies used make LINUS especially attractive for heavy-use applications – such as in sports facilities.

Manual self-closing



Self-closing concealed
washbasin tap
LINUS W-SC

- High-pressure mixed or cold water
- 3 different draw-off tap lengths
- Front panel chrome-plated brass or stainless steel

All taps at a glance. Keeping you in the picture.





Since no facility is quite like another, we offer a wide choice of washbasin taps to meet your needs. Choose your installation type, operation style and design. At SCHELL, you're sure to find the right product.

| Standard taps | XERIS | PURIS | VENUS | CELIS |
|---|--|---|--|---|
| Contact-free with infrared sensor | XERIS E-T XERIS E  | PURIS E*  | VENUS E*  | CELIS E  |
| Manual self-closing with cartridge technology | XERIS SC  | PURIS SC  | | |
| With single lever | | | | |
| Open/Closed | | | | |

| Exposed washbasin taps | | | | |
|---|--|--|--|--|
| Contact-free with infrared sensor | | | | |
| Electronic self-closing with CVD touch sensor | | | | |
| Manual self-closing with cartridge technology | | | | |
| With single lever | | | | |
| With arm lever | | | | |
| Open/Closed | | | | |

| Concealed washbasin taps | | | | |
|---|--|--|--|--|
| Contact-free with infrared sensor | | | | |
| Manual self-closing with cartridge technology | | | | |

* For high and low pressure

| MODUS | | PETIT | |
|----------|---|----------|---|
| MODUS E |  | | |
| | | PETIT SC |  |
| MODUS EH |  | | |
| MODUS K |  | | |

| VITUS | | | |
|-------|----------|---|---|
| | | | VITUS VW-E-T  |
| | | | VITUS VW-C-T  |
| | PETIT SC |  | VITUS VW-SC  |
| | | | VITUS VW-EH  |
| | | | VITUS VW-AH  |
| | | | VITUS VW Open/Close  |

| LINUS | | | |
|-------|--|--|--|
| | | | LINUS W-E  |
| | | | LINUS W-SC  |

Mounting solutions

Add the finishing touch to your washbasin installations with our mounting modules for a wide range of scenarios. Alongside optimum functionality, they also offer a high standard of protection against structure-borne noise.



You can always depend on our taps. And on our service.

Do you have a question? Just ask. It costs nothing and in some cases could even avoid costly claims for damages. As a worldwide expert for modern tap technologies we are ready to offer you advice and assistance anywhere and at any time.

Our inside/outside and after sales teams provide you with answers to specific enquiries about planning, installation and using our products – both on your premises and on the construction site.

We are pleased to invite you to visit us, we offer a **wide range** of practical seminar courses in our modern training centre at our company headquarters. Theory is skilfully combined with engaging practice exercises to ensure you can work even more successfully than before.

We also regularly offer seminar series in a number of cities in Germany on selected issues of contemporary relevance. These offer an attractive package consisting of an interesting venue, seasoned experts and first-class solutions from SCHELL.

Looking for information about our company and our products?

You'll find everything you need with a visit on www.schell.eu. Our web presence makes full use of the opportunities offered by digitalisation to offer you product literature, PDF files of our brochures and tender texts, an ever-expanding database of reference projects, and engaging installation and product videos. Our regular newsletter also keeps you up-to-date with all the news. Our brochures and product leaflets are naturally still available as traditional printed materials. You can meet us in person at industry trade fairs throughout Germany. Or call us to arrange an appointment.

**You can reach us on +49 2761 892-0
or at info@schell.eu.**

We look forward to hearing from you.

Made in Olpe. In demand worldwide.

A hygiene solution from SCHELL is increasingly the product of choice for planners, architects, installers and property developers – for new buildings and renovations, for stadiums, universities, hotels and swimming baths. SCHELL's uncompromising, 'Made in Germany' quality sets the highest of standards when it comes to optimum drinking and process water hygiene. And it does so all over the world.

Here are just a few examples:

- 1 Camping Le Brasilia, Canet-en-Roussillon
 - 2 Leisure pool, Olpe
 - 3 Continental Arena, Regensburg
 - 4 Fitness club PURE, Kornwestheim
 - 5 University of Duisburg-Essen
 - 6 Holiday Inn, Nice
-



SCHELL GmbH & Co. KG
Armaturentechnologie
Raiffeisenstraße 31
57462 Olpe
Germany
Tel. +49 2761 892-0
Fax +49 2761 892-199
info@schell.eu
www.schell.eu

